

BellSouth  
**Premium Systems®**

# User's Manual

**BellSouth National Help Desk**  
**TOLL FREE: 1-800-298-0973**

Model: BS5822

**58**  
GHz  
Digital Spread  
Spectrum

# Table of contents

|   |          |  |    |
|---|----------|--|----|
| <b>Getting started</b> . . . . .                      | <b>3</b> | Intercom call . . . . .                                | 14 |
| Before you begin . . . . .                            | 3        | Call forward . . . . .                                 | 15 |
| Parts checklist . . . . .                             | 3        | Find handset . . . . .                                 | 15 |
| Installation . . . . .                                | 4        | Handset display screen messages . . . . .              | 16 |
| Choose a location . . . . .                           | 4        | Telephone settings . . . . .                           | 18 |
| Install handset battery . . . . .                     | 4        | Ringer volume . . . . .                                | 18 |
| Table/desk installation . . . . .                     | 5        | Ring tone . . . . .                                    | 18 |
| Charge the handset battery . . . . .                  | 6        | Key tone . . . . .                                     | 19 |
| Check for dial tone . . . . .                         | 6        | Language . . . . .                                     | 19 |
| Belt clip . . . . .                                   | 6        | Dial type . . . . .                                    | 19 |
| To register your accessory handsets . . . . .         | 7        | Phonebook . . . . .                                    | 20 |
| Re-register existing handsets to a new base . . . . . | 7        | Store a new entry . . . . .                            | 20 |
| Wall mounting . . . . .                               | 8        | Review/dial from the phonebook . . . . .               | 21 |
| <b>Basic operation</b> . . . . .                      | <b>9</b> | Edit a phonebook entry . . . . .                       | 22 |
| Handset and base indicators . . . . .                 | 9        | Delete a phonebook entry . . . . .                     | 22 |
| Handset display . . . . .                             | 9        | Caller ID . . . . .                                    | 23 |
| Base display . . . . .                                | 9        | Shared call log . . . . .                              | 23 |
| Handset layout . . . . .                              | 10       | About call history (caller ID) . . . . .               | 24 |
| Base unit layout . . . . .                            | 11       | Review call history . . . . .                          | 24 |
| Handset operation . . . . .                           | 12       | Delete records from call history . . . . .             | 24 |
| Making calls . . . . .                                | 12       | Delete a specific call . . . . .                       | 24 |
| Answering calls . . . . .                             | 12       | Delete all calls . . . . .                             | 24 |
| Flash function . . . . .                              | 12       | Dial a displayed number . . . . .                      | 24 |
| Redial . . . . .                                      | 12       | Store a call history record in the directory . . . . . | 25 |
| Mute . . . . .  | 13       | Voice mail . . . . .                                   | 26 |
| Conference call . . . . .                             | 13       | Access voicemail . . . . .                             | 26 |
| Volume control . . . . .                              | 13       | Clear voicemail . . . . .                              | 26 |
| Transferring calls . . . . .                          | 13       | Program the password . . . . .                         | 27 |

## Table of contents

|   |           |
|---|-----------|
| Program the voicemail key . . . . .         | 27        |
| Program the play key . . . . .              | 27        |
| Program the skip key. . . . .               | 28        |
| Program the erase key. . . . .              | 28        |
| Reset all codes. . . . .                    | 28        |
| Custom pay-per-use (PPU) features . . . . . | 29        |
| PPU keys on handset . . . . .               | 29        |
| Change PPU key setting. . . . .             | 29        |
| Change auto call back number . . . . .      | 29        |
| Change 3-way calling number . . . . .       | 30        |
| Change repeat dialing number. . . . .       | 30        |
| Reset all codes. . . . .                    | 30        |
| Headset . . . . .                           | 31        |
| Operating range . . . . .                   | 31        |
| Batteries . . . . .                         | 32        |
| Battery care and maintenance. . . . .       | 32        |
| Replacing the handset battery. . . . .      | 32        |
| <b>Additional information . . . . .</b>     | <b>33</b> |
| Troubleshooting . . . . .                   | 33        |
| Maintenance . . . . .                       | 39        |
| Warranty . . . . .                          | 39        |
| Important safety instructions . . . . .     | 40        |
| FCC, ACTA and IC regulations. . . . .       | 41        |
| The RBRC® seal . . . . .                    | 42        |
| Technical specifications . . . . .          | 43        |
| Index . . . . .                             | 44        |

## Before you begin

### Parts checklist:

1. Handset
2. Base unit
3. Base wall mount bracket
4. Battery
5. Telephone line cord
6. Belt clip
7. AC power adaptor
8. User's manual



Handset

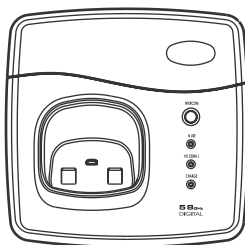

Base unit

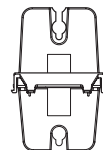

Base wall  
mount bracket



Battery



Telephone line cord



Belt clip

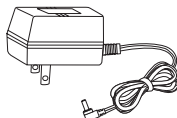

AC power adaptor



User's manual

### note

- **Important!** Before using this telephone, you must read the important safety instructions on page 40.

## Installation

### Choose a location

For maximum performance of your cordless telephone system:

1. Choose a central location for your base unit.
2. Install your base unit and extension handsets away from electronic equipment, such as personal computers, television sets and microwave ovens.
3. In locations where there are multiple cordless telephones, separate base units as much as possible.
4. Install your telephone equipment away from heat sources and sunlight.
5. Avoid excessive moisture, dust or extreme cold.

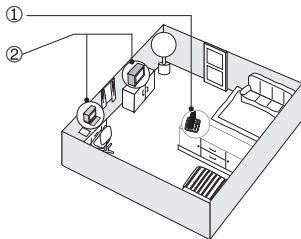

### Install handset battery

1. Align the two holes in the plug with the socket pins, then snap the plug into place.
2. Place the battery in the compartment with the wires in the upper left corner.
3. Replace cover by sliding it upwards until it clicks into place.
4. Be sure to charge the battery in the handset for a minimum of 16 hours before using your phone.

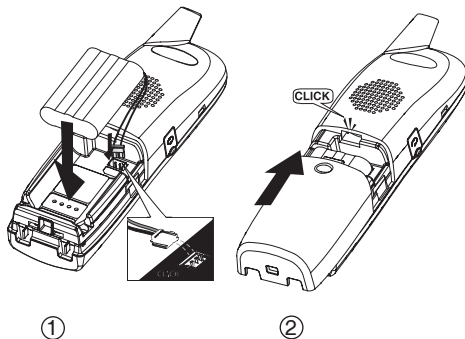

# Installation

## Table/desk installation

Connect the power cord. After charging the battery for at least 16 hours, connect the telephone line cord.

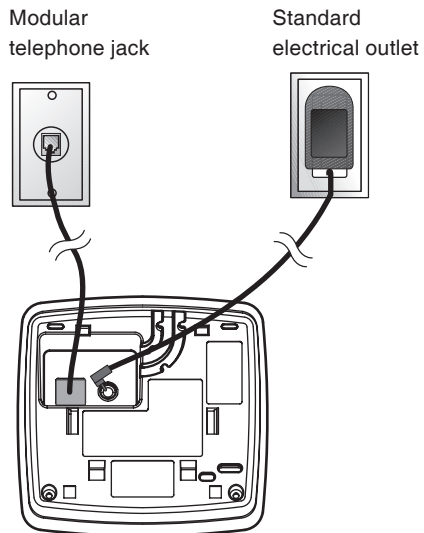

### note

- Install the base unit away from electronic equipment such as personal computers, television sets or microwave ovens. Avoid excessive heat, cold, dust or moisture.

## note

- Your phone contains an internal noise filter (for DSL subscribers). This means, if you subscribe to DSL service, you shouldn't experience interference or noise when using your phone due to your DSL service.

## Installation

### Charge the handset battery

Place the handset in the base. Be sure to charge the battery for at least 16 hours before using your phone.

### Check for dial tone

After the batteries are charged, pick up the handset and press **ON**; you should hear a dial tone. If you do not, try this phone in another phone jack.

### Belt clip (optional)

Your phone can operate up to four handsets. To order additional handsets call the supplier.

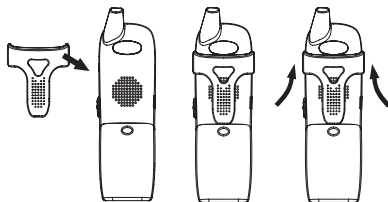

To attach

To remove

## Installation

### To register your accessory handsets

Your phone comes with a handset which is already registered as Handset 1. Your phone can operate up to four handsets, to order additional handsets call the supplier.

1. After charging the battery, the screen will display:
2. On the base unit, press **MENU/SEL**, then scroll to **DISPLAY BASE ID**, press **MENU/SEL**.
3. Enter the 15 digit base unit ID code, if you make a mistake, press the **DELETE/MUTE** key to backspace (delete characters), then enter the correct information.
4. Press **MENU/SELECT** to complete the registration process.
5. Once a valid base ID code has been entered, the display will go blank for a second or two, and then show:
6. If the base accepts the new handset, after several seconds the new handset will show:

### Re-register existing handsets to a new base

1. Install your new base unit, the handset(s) will display **SEARCHING...**, press and hold the **MENU/SELECT** button for two seconds.
2. The handset will display:
3. Follow steps 2 through 6 in **To register your accessory handsets**, above.

```
ENTER BASE ID
#####
```

```
SEARCHING...
```

```
HANDSET 2
```

```
SEARCHING...
```

```
ENTER BASE ID
#####
```

### note

- The 15-digit base ID code may contain numbers and characters, including 0 through 9 and \*. Make sure you enter all 15 digits.
- If you do not enter the correct digit sequence, you will hear an error tone. Press **DELETE/MUTE** key to backspace to erase a character(s) and carefully re-enter the base ID code.



## note

- Install the base unit away from electronic equipment such as personal computers, television sets or microwave ovens. Avoid excessive heat, cold, dust or moisture.

## Wall mounting (optional)

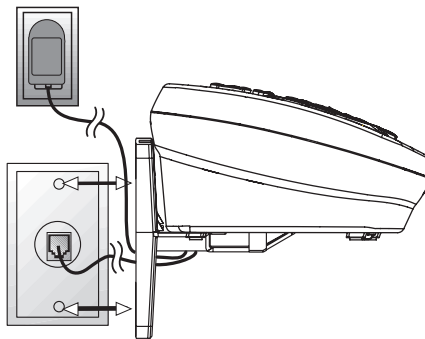

The wall mount brackets are designed for use on standard wall mount plates only.

1. Follow the instructions on page 6 to connect the power to base and phone line.
2. Line up the tabs on the wall mount adaptor with the holes at the bottom of the base. Snap the wall mount bracket firmly in place.
3. Mount the telephone base on the wall. Position the telephone base so that the mounting studs fit into the holes on the wall mount bracket. Slide telephone base down on the mounting studs until it locks into place.



## Handset and base indicators

### Handset display

| Icon  | Description   |
|---|---|
| MUTE  | Turns on when the microphone is muted.  |
| NEW   | Turns on when there are new call log entries.   |
|  | Turns on when the ringer is muted.  |
|  | Low battery indicator and charging indicator.   |
|  | LED is on when in handsfree mode.   |
| VOICEMAIL   | On when new voicemail is detected. Service must be subscribed through your local telephone company. |

### Base display

| Icon      | Description   |
|-----------|---|
| IN USE    | On when the phone is off hook.  |
| CHARGE    | On when the handset is charging in the base.  |
| VOICEMAIL | On when new voicemail is detected. Service must be subscribed through your local telephone company. |

## Handset layout

1. Antenna
2. CID ▼
3. Redial/pause
4. On/flash
5. Dialing key (0 - 9, \*, #)
6. Voicemail
7. Play ▶
8. Skip ▶▶
9. Menu/select
10. ☐ Phonebook/▲
11. Speaker
12. Mute/delete
13. Off/clear
14. Billed services
15. Intercom
16. Erase X

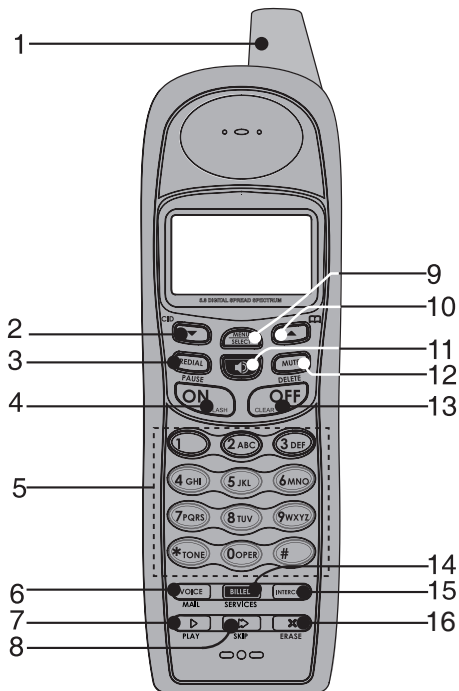

## Base unit layout

1. Intercom
2. In use
3. Voicemail
4. Charge

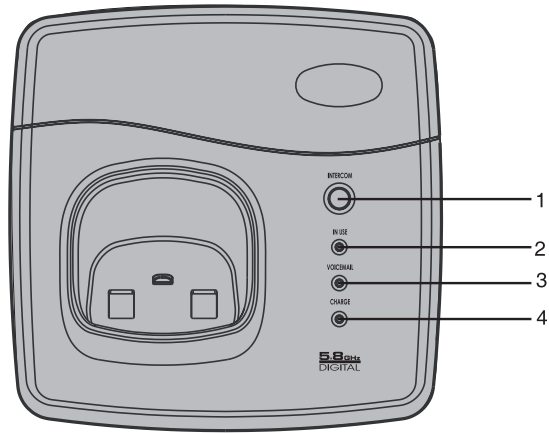

## note

- Use **FLASH** to access other phone company subscriber services, as described by your provider.
- To end a conference call, press **OFF** at the handset. The conference call will not be terminated until all handsets have disconnected from the call.

## Handset operation

### Making calls

Press **ON** (or, **SPEAKER** (  )) to use the handset speakerphone feature. Dial the phone number.

#### -OR-

Dial the phone number first; then press **ON** or **SPEAKER** (  ).

As you are entering numbers, press **DELETE/MUTE** or **OFF/CLEAR** to backspace and make corrections, or press and hold **PAUSE** to enter a three second dialing pause. Press **OFF** to end your call.

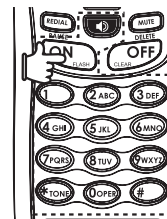



### Answering calls

- Press **ON**, **SPEAKER** or any of the number keys.
- Press **OFF** to end your call.

### Flash function

You can use your phone with services such as call waiting. When you receive a call waiting signal, simply press the **FLASH** key to switch to the new call. Press **FLASH** again to switch back to the original call.

### Redial

- Press **REDIAL** to display the last telephone number dialed from the handset or base unit (up to 32 digits). Use  or  to scroll through the five previously dialed numbers. When the beginning or the end of the redial list is reached, a double beep will sound.
- When the desired number is reached, press **ON** or **SPEAKER** (  ) to dial.
- Press **DELETE/MUTE** on the handset to delete the number from the redial memory.
- Press **OFF/CLEAR** on the handset to exit the redial review list.

## Handset operation

### Mute

- During an active call, press the **MUTE** key on handset to disable the microphone. The screen will display:
- Press **MUTE** again to return to normal two way conversation. **MICROPHONE ON** will display briefly.

```
PHONE 00:00:25
MICROPHONE MUTED
MUTE
```

### Conference call

Your phone is capable of supporting conference calls between system handsets. It is possible to establish a conference between any two handsets and the external line.

If a handset already has a connection to the external line, and any other handset goes off-hook, a conference is immediately established.

The handsets will show:

```
PHONE 00:00:25
```

### Volume control

Press the **VOLUME** button  on the handset to adjust listening volume. Each button press raises or lowers volume by one level. When you change the volume level, the new setting is saved. The new volume level will be applied each time you use the handset, speakerphone or headset.

### Transferring calls

You can transfer calls between any handsets registered to it.

While you are on an external call, Using Transfer allows you to speak to the person who answers at the handset you are calling before releasing the external call to them.

- Press **INTERCOM** key on the handset, it will display:
- Select the number of the handset to which the call is to be transferred 1-4. For example if you intercom handset 2 the display will show:

```
TRANSFER TO:
```

```
CALLING
HANDSET 2
```

### note

- If the returned call is not answered within 30 seconds, the external call will end automatically.
- While in transfer mode (before releasing the call) you may toggle back and forth between the external call (the display will show **OUTSIDE**) and the intercom call (the display will show **INTERCOM**) by pressing the **INTERCOM** key.

## Handset operation

- Press **ON**, **SPEAKER** or **INTERCOM** on the handset being called to answer the intercom call. You may now discuss the external call with the person who answered the other handset.
- On the handset, press the **OFF** key to transfer the external call to the other handset.

HANDSET 1  
IS CALLING

CALL TRANSFERRED

### Intercom call

You can intercom between any handsets registered to it.

- From the idle (off) mode, press **INTERCOM**. The handset will display:
- Select a number of the handset to be called (1-4).
- Press **INTERCOM**, **ON** or **SPEAKER** (  ) on the handset to answer the intercom call. The screens will display:
- Press **INTERCOM**, **OFF/CLEAR** on the handset to end the call.

INTERCOM TO:

CALLING  
HANDSET1

INTERCOM

If the handset you are attempting to intercom is out of range, or on an external call, the display will show:

UNABLE TO CALL  
TRY AGAIN

## Handset operation

### Call forward

You can forward calls between any handsets registered to it.

- A handset on an external call can forward it to any other handset.
- Press and hold the **INTERCOM** key on the handset, it will display:
- Enter the handset number you wish to forward to.  
The handset will display:
- At the handset press **ON, SPEAKER** or any of the dialing keys (0-9, \*, #) to answer the call.



FORWARD TO:



CALL FORWARDED

If the handset being called does not respond in about one minute, the external call will be returned to originating handset and the display will show:



CALL BACK

### Find handset

Locate a missing handset from the base unit by using these steps:

- With the handset in idle, press **FIND HANDSET**.
- To end the page at the handset, press **ON, SPEAKER** or any dial pad key (0-9, \*, #) on handset, or press **FIND HANDSET** at the base.



## Handset operation

### Handset display screen messages

| Screen displays:  | When:   |
|-------------------|---|
| PHONE             | The handset is in use.                            |
| ENDED             | The handset is on hook.                           |
| NO ENTRIES        | You are accessing an empty directory or call log. |
| LIST FULL         | You are saving to a full directory.               |
| MICROPHONE MUTED  | The call is on mute.                              |
| SPEAKER           | The handset speakerphone is in use.               |
| LOW BATTERY       | The battery needs to be recharged.                |
| INCOMING CALL     | There is a call coming in.                        |
| NEW VOICE MAIL    | There are new voicemail messages.                 |
| X NEW CALLS       | There are new calls in the CID log.               |
| SEARCHING...      | The handset has lost communication with the base. |
| BASE IS PAGING    | The base is paging handset(s).                    |
| CALLING HANDSET X | Calling another handset.                          |

# Handset operation

## Handset display screen messages

| Screen displays:       | When:   |
|------------------------|---|
| HANDSET X IS CALLING   | Other handset is calling.   |
| LINE IN USE            | An extension phone is in use.   |
| NO LINE                | There is no telephone line connected.   |
| ALREADY SAVED          | The telephone number you have entered is already stored in the directory.   |
| SAVED                  | Your operation is successful.   |
| WARNING CHECK BATTERY! | <ul style="list-style-type: none"><li>• The battery is not installed properly in the handset.</li><li>-OR-</li><li>• The battery needs to be replaced.</li><li>-OR-</li><li>• An incorrect battery has been installed by mistake.</li></ul> |
| PLACE IN CHARGER       | The battery is very low. The handset should be placed in the base unit or charger.  |
| CHARGING               | A handset with a low battery has been placed in the base unit or charger.   |

## Telephone settings

### Ringer volume

- From the idle (off) mode, press **MENU/SELECT** on the handset then the **▲** or **▼** key to **RINGER VOLUME**.

```
> RINGER VOLUME
  RINGER TONE
```

- Press **MENU/SELECT** on the handset. The current ringer volume will be shown:

```
RINGER VOLUME
|||||
```

- Press the **▲** or **▼** keys or enter a digit (0 through 6) to the desired volume. The current ring tone is played. At the lowest setting, display will show:

```
RINGER VOLUME 
```

The handset will not ring when a call comes in if ringer volume is set to the lowest setting.

- Press **MENU/SELECT** on the handset.

### Ring tone

- From the idle (off) mode, press **MENU/SELECT** on the handset then the **▲** or **▼** key to **RINGER TONE**.
- Press **MENU/SELECT** on the handset.
- Press the **▲** or **▼** keys (or enter a digit 0 through 9) to sample the ring tones. The screen will show:
- Press **MENU/SELECT** on the handset.

```
> RINGER TONE
  KEY TONE
```

```
RINGER TONE
1
```

## Telephone settings

### Key tone (preset to on)

- From the idle (off) mode, press **MENU/SELECT** on the handset then the **▲** or **▼** keys to select **KEY TONE**.
- Press **MENU/SELECT** on the handset. The current setting will be shown. Use the **▲** or **▼** keys to scroll to **ON** or **OFF**. When set to on, the handset will emit a beep whenever a key is pressed.
- When the desired option is shown, press **MENU/SELECT** on the handset.

```
> KEY TONE
  LANGUAGE
```

```
KEY TONE
ON
```

### Language (preset to English)

- From the idle (off) mode, press **MENU/SELECT** on the handset then the **▲** or **▼** keys to **LANGUAGE**.
- Press **MENU/SELECT** on the handset. Press the **▲** or **▼** keys to select between English, Spanish or French.
- Press **MENU/SELECT** on the handset.

```
> LANGUAGE
  CLR VOICE MAIL
```

```
LANGUAGE
ENGLISH
```

### Dial type (preset to tone)

- From the idle (off) mode, press **MENU/SELECT** on the handset then **▲** or **▼** keys to **DIAL TYPE**.
- Press **MENU/SELECT** on the handset then use **▲** or **▼** keys to scroll from **PHONEBOOK** to **PULSE**.
- Press **MENU/SELECT** on the handset.

```
> DIAL TYPE
  PHONEBOOK
```

```
DIAL TYPE
TONE
```

### note

- When the phone is set for pulse dial mode, it is possible to switch to temporary tone mode during an ongoing call by pressing **\***. Once pressed, tone will be used for rest of the call. After you hang up, the phone will return to pulse dialing for the next call.

## note

- If you register additional handsets to your base, the handsets share a common phonebook, which is stored in the base. This means that entries inserted by a handset are available for all handsets and if one deletes a phonebook entry, it will disappear from all handsets.

## Phonebook

Your phone can store up to 50 numbers with names in memory. Each memory location can hold up to 32 digits for the number and 16 characters for the name.

### Store a new entry

- Press **MENU/SELECT** on the handset.
- With **PHONEBOOK** highlighted, press **MENU/SELECT** on the handset.
- Press **▲** or **▼** to select **STORE**. Press **MENU/SELECT** on the handset.
- You will be prompted to **ENTER NUMBER**.

Use the dialing keys to enter the number you wish to store in the directory. Press the **DELETE/MUTE** on the handset to backspace and make corrections. Press **MENU/SELECT** on the handset.

- You will then be prompted to **ENTER NAME**. Use the dialing keys to spell the name. Use the **▲** and **▼** keys to move the cursor. Press **DELETE/MUTE** on the handset to backspace and make corrections. Press **MENU/SELECT** on the handset.
- You'll hear a confirmation tone, and the new phonebook entry will be displayed.
- If the phonebook is full, the handset or base unit will display:
- You can also press **REDIAL** then **▲** or **▼** keys to scroll to the previously dialed number from the redial list you want to store in the phonebook. Press **MENU/SELECT** on the handset.
- While entering numbers, press and hold **PAUSE** to add pauses if necessary.
- If there is a duplicate number in the phonebook, the display will show:

```
> STORE  
REVIEW
```

```
ENTER NUMBER  
555-123-4567_
```

```
ENTER NAME  
--
```

```
LIST FULL
```

```
ALREADY SAVED
```

## Phonebook

Each press of a particular key causes characters to be displayed in the following order:

| Key | # of key presses |   |   |   |   |   |   |   |   |
|-----|------------------|---|---|---|---|---|---|---|---|
|     | 1                | 2 | 3 | 4 | 5 | 6 | 7 | 8 | 9 |
| 1   | 1                | # | ' | , | - | . | & |   |   |
| 2   | A                | B | C | 2 | a | b | c |   |   |
| 3   | D                | E | F | 3 | d | e | f |   |   |
| 4   | G                | H | I | 4 | g | h | i |   |   |
| 5   | J                | K | L | 5 | j | k | l |   |   |
| 6   | M                | N | O | 6 | m | n | o |   |   |
| 7   | P                | Q | R | S | 7 | p | q | r | s |
| 8   | T                | U | V | 8 | t | u | v |   |   |
| 9   | W                | X | Y | Z | 9 | w | x | y | z |
| 0   | 0                |   |   |   |   |   |   |   |   |
| *   | *                | ? | ! | / | ( | ) | @ |   |   |
| #   | space            |   |   |   |   |   |   |   |   |

### Review/dial from the phonebook

- Press **MENU/SELECT** on the handset. With **PHONEBOOK** highlighted, press **MENU/SELECT** on the handset. With the desired phonebook entry highlighted, press **MENU/SELECT** on the handset.

**-OR-**

With the handset in idle, press ▲, the handset goes directly into phonebook review mode.

```
Andrew
123-4567
```

## note

- When reviewing the phonebook, the second line of the display will show the phone number, up to 16 digits. For numbers longer than 16 digits, only the first 13 digits will be shown. Press \* or # to scroll the phone number to see the additional digits.
- If there are no entries in the phonebook, when it is accessed, **NO ENTRIES** will display.

## Phonebook

- Scroll through the phonebook entries using the ▲ and ▼ keys or enter first character of the name to be searched (using the digit keys) and continue navigating using the ▲ or ▼ keys as scroll keys, until you reach the entry to be dialed.
- Press **ON** or **SPEAKER** (  ), to dial the number.

### Edit a phonebook entry

- Follow the first two steps in **Review/dial from the phonebook** (page 21) to reach the entry to be edited.
- Press **MENU/SELECT** on the handset.
- Press **DELETE/MUTE** on the handset to backspace then enter the correct number. Press and hold **PAUSE** to add pauses if necessary. You can also press **REDIAL**, then the ▲ or ▼ keys to scroll to the previously dialed number from redial list you want to store in the phonebook. Press **MENU/SELECT** on the handset.
- Press **MENU/SELECT** on the handset.
- You are now prompted to **EDIT NAME**. Press **DELETE/MUTE** on the handset to backspace, then use the dialing keys to enter the correct name (see page 21). Use the ▲ and ▼ keys to move the cursor.
- Press **MENU/SELECT** on the handset. A confirmation tone will sound.

### Delete a phonebook entry

- Follow the first two steps in **Review/dial from the phonebook**.
- Press **DELETE/MUTE** on the handset. A confirmation tone will sound.
- The handset or base will then move to the next entry if any.

```
Andrew Smith
555-123-4567
```

```
PHONE 00:00:10
Andrew Smith
```

```
Andrew Smith
555-123-4567
```

```
EDIT NAME
Andrew
```

```
Andrew Smith
555-123-4567
```

## Caller ID

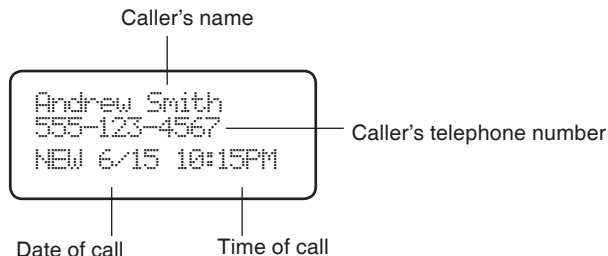

### Shared call log

The caller ID log is stored in the base, and is shared by the system handsets. Changes made at a handset will be reflected in all handsets.

If the number of an incoming call matches an entry in your directory, the name will display exactly how you've entered it in the phonebook. For example, if Christine Smith calls, her name will appear as Chris if that is how you entered it into the phonebook.

Your phone has a caller ID (CID) with call waiting feature that works with service from your local phone service provider. Caller ID with call waiting lets you see who's calling before you answer the phone, even when you're on another call.

You may need to change your phone service to use this feature. Contact your service provider if:

- You have both caller ID and call waiting, but as separate services (you may need combined service)
- You have only caller ID service, or only call waiting service.
- You don't subscribe to any caller ID or call waiting services.

You can use this product with regular caller ID service, and you can use this product's other features without subscribing to either caller ID or combined caller ID with call waiting service.

There are fees for caller ID services, and they may not be available in all areas.



## note

- If you answer a call before the caller ID information appears on the screen, it will not be in the call history.

## Caller ID

This product can provide information only if both you and the caller are in areas offering caller ID service, and if both telephone companies use compatible equipment.

### About call history (caller ID)

Your phone can store up to 50 calls in its caller ID memory. When the memory is full, the oldest call will be deleted to make room for new incoming call information. For each call that comes in, the screen displays the following information between the first and second rings:

- Your caller's name (15 letters are sent by your telephone company).
- The caller's area code and telephone number.
- The time and date of the call.

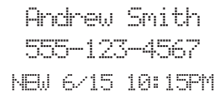
A rectangular box containing a monospaced font display of caller ID information. The text is arranged in three lines: the first line shows the name "Andrew Smith", the second line shows the phone number "555-123-4567", and the third line shows the time and date "NEW 6/15 10:15PM".

Andrew Smith  
555-123-4567  
NEW 6/15 10:15PM

### Review call history

- Press ▼ (CID) to view call history.
- Use ▲ and ▼ to scroll through records in call history.

### Delete records from call history

#### Delete a specific call:

- Locate the record you want to delete from call history.
- Press **DELETE/MUTE** on the handset. You'll hear a confirmation beep.

#### Delete all calls:

- With the handset in call log mode, press and hold **DELETE/MUTE** on the handset. The screen displays:
- Press **MENU/SELECT** on the handset. You'll hear a confirmation beep.

A rectangular box containing a monospaced font display of a confirmation message. The text is arranged in two lines: the first line shows "DELETE ALL" and the second line shows "CALLS?".

DELETE ALL  
CALLS?

## Caller ID

### Dial a displayed number

- Locate the record in call history that you want to dial.
- If you wish to change how the number is dialed, press #. The screen displays alternate dialing sequences available for this call.

When the number is correctly displayed for dialing, press **ON** or **SPEAKER**.

### Store a call history record in the directory

1. Locate the record in the call history you want to store in the directory.
2. If you wish to change how the number is stored, press #. The screen displays alternate dialing sequences available for this call.
3. Press **MENU/SELECT** on the handset, you'll hear a confirmation beep.

| Screen displays: | When:   |
|------------------|---|
| PRIVATE NUMBER   | The other party is blocking name and/or number information.                                 |
| UNKNOWN NUMBER   | Your phone company is unable to receive information about this caller's name and/or number. |

### note

- Press **OFF/CLEAR** on the handset(s) at any time to exit call history.
- If both the name and number are not provided, **UNABLE TO SAVE** will be displayed.

## note

- In order to use these features, you must subscribe to and activate voicemail service through your local telephone company.
- When one handset is accessing the voicemail setup, the other handset(s) cannot access it at the same time. If this is attempted, **NOT AVAILABLE AT THIS TIME** will be displayed.

## Voicemail

### Access voicemail

When a voicemail is detected, **VOICEMAIL** key will be illuminated and **NEW VOICEMAIL** will display on the handset.

Once your voicemail access number and password are programmed into your phone, you can quickly retrieve voicemail messages by pressing the **VOICEMAIL** key on the handset.

When retrieving voicemail messages, you can use the dedicated **PLAY**, **SKIP** and **ERASE** keys on the handset to access play, skip and erase messages functions.

### Clear voicemail

If you wish to manually turn off the voicemail indications on the handset, follow the steps below:

From the idle mode, press **MENU/SELECT** on the handset, then the **▲** or **▼** keys to **CLR VOICEMAIL**. Press **MENU/SELECT** on the handset, the screen will display **TURN INDICATOR OFF?** Press **MENU/SELECT** on the handset.

### Programming the Voicemail Access Keys

Your phone is factory programmed with the appropriate key sequences for **PLAY**, **SKIP**, **ERASE** and **VOICEMAIL** keys. If the default programming for these or password do not work with your voicemail system, you can reprogram them.

From the idle mode, press **MENU/SELECT** on the handset, use **▲** or **▼** to scroll to **FEATURE CODES**, then press **MENU/SELECT** on the handset. With **VOICEMAIL SETUP** displayed, press **MENU/SELECT** on the handset. Use **▲** or **▼** to scroll to your desired option, then press **MENU/SELECT** on the handset.

## Voicemail

You can access the following options:

**ACCESS NUMBER    PASSWORD    PLAY    SKIP    ERASE    RESET ALL CODES**

### Program the password

You need to program a password to access your voicemail. First, you must activate and define your voicemail password with the voicemail service provided by your local telephone company. Once you have defined your password, you can then program it into the phone.

Use **▲** or **▼** to scroll to **PASSWORD**, then press **MENU/SELECT** on the handset to choose it. You will see the following display:

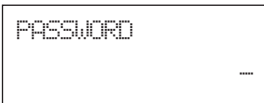

PASSWORD  
\_\_\_\_\_

Use the number keys to enter the password number provided by your local telephone company. To enter pauses, press and hold **PAUSE**. Press **DELETE/MUTE** on the handset to erase numbers if you make a mistake. When finished press **MENU/SELECT** on the handset.

### Program the voicemail key

The default voicemail access number is **\*98**. If this does not match the number provided by your local telephone company, you will need to edit the number.

Use **▲** or **▼** to scroll to **ACCESS NUMBER**, then press **MENU/SELECT** on the handset. You see the following display:

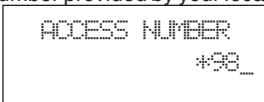

ACCESS NUMBER  
\*98\_\_\_\_

Press **DELETE/MUTE** on the handset. Enter the new voicemail access number provided by your local telephone company. To enter pauses, press and hold **PAUSE**. When finished press **MENU/SELECT** on the handset.

### Program the play key

The default **PLAY** key number is 1. If this does not match the number provided by your local telephone company, you will need to edit the number.

Use **▲** or **▼** to scroll to **PLAY**, then press **MENU/SELECT** on the handset. The display will show:



PLAY  
1\_\_\_\_

## Voicemail

Press **DELETE/MUTE** on the handset. Enter the new number provided by your local telephone company. To enter pauses, press and hold **PAUSE**. When finished press **MENU/SELECT** on the handset.

### Program the skip key

The default **SKIP** password is **#**. If this does not match the password provided by your local telephone company, you will need to edit the password.

Use **▲** or **▼** to scroll to **SKIP**, then press **MENU/SELECT** on the handset. You see the following display:



SKIP  
#\_

Press **DELETE/MUTE** on the handset. Enter the new password provided by your local telephone company. To enter pauses, press and hold **PAUSE**. When finished press **MENU/SELECT** on the handset.

### Program the erase key

The default **ERASE** key number is **3**. If this does not match the number provided by your local telephone company, you will need to edit the number. Use **▲** or **▼** to scroll to **ERASE**, then press **MENU/SELECT** on the handset.

You see the following display:



ERASE  
3\_

Press **DELETE/MUTE** on the handset. Enter the new number provided by your local telephone company. To enter pauses, press and hold **PAUSE**. When finished press **MENU/SELECT** on the handset.

### Reset all codes

You can reset all voicemail codes to their default values.

Use to scroll to **RESET ALL CODES**, then press **MENU/SELECT** on the handset. You see the following display:

Press **MENU/SELECT** on the handset.

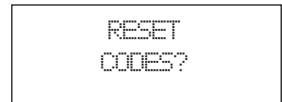

RESET  
CODES?

## Custom pay-per-use (PPU) features

### PPU keys on handset

To access PPU features on the handsets:

- Press **ON**.
- Press **BILLED SERVICES** key, then use the ▲ or ▼ keys to scroll to your desired option.
- Press **MENU/SELECT** on the handset.

### Change PPU key setting

Your phone is factory programmed with the PPU keys, you can reprogram the codes to the numbers provided by your local telephone company.

From the idle mode, press **MENU/SELECT on the handset**, use ▲ or ▼ to scroll to **FEATURE CODES**, then press **MENU/SELECT on the handset**. Press ▲ or ▼ to scroll to **BILLED SERVICES**, then press **MENU/SELECT on the handset**. Use ▲ or ▼ to scroll to your desired option, then press **MENU/SELECT on the handset**.

You can access the following options:

**AUTO CALLBACK**                      **3-WAY CALLING**                      **REPEAT DIALING**  
**RESET ALL CODES**

### Change auto call back number

The default **AUTO CALLBACK** number is \*69. If this does not match the number provided by your local telephone company, you will need to edit the number.

Use ▲ or ▼ to scroll to **AUTO CALLBACK**, then press **MENU/SELECT** on the handset. The display will show:

```
AUTO CALLBACK
*69 _
```

### note

- Your local telephone company may provide a monthly subscription to an individual service or a package of services which gives you unlimited usage for a small monthly fee.

## Custom pay-per-use (PPU) features

Press **DELETE/MUTE on the handset**. Enter the new number provided by your local telephone company. To enter pauses, press and hold **PAUSE**. When finished press **MENU/SELECT on the handset**.

### Change 3-way calling number

The default **3-way calling** code is **F** (flash). If this does not match the number provided by your local telephone company, you will need to edit the number.

Use **▲** or **▼** to scroll to **3-WAY CALLING**, then press **MENU/SELECT** on the handset. You see the following display:



3-WAY CALLING  
F \_

Press **DELETE/MUTE** on the handset. Enter the new number provided by your local telephone company. To enter pauses, press and hold **PAUSE**. When finished press **MENU/SELECT** on the handset.

### Change repeat dialing number

The default repeat dialing number is **\*66**. If this does not match the number provided by your local telephone company, you will need to edit the number.

Use **▲** or **▼** to scroll to **REPEAT DIALING**, then press **MENU/SELECT** on the handset. The display will show:



REPEAT DIALING  
\*66 \_

Press **DELETE/MUTE** on the handset. Enter the new number provided by your local telephone company. To enter pauses, press and hold **PAUSE**. When finished press **MENU/SELECT** on the handset.

### Reset all codes

You can reset all PPU codes to their default values.

Use **▲** or **▼** to scroll to **RESET ALL CODES**, then press **MENU/SELECT** on the handset. You see the following display:



RESET  
CODES?

Press **MENU/SELECT** on the handset.

## Headset operation

### Headset

You can use this telephone handsfree when you install a compatible 2.5 mm headset, purchased separately.

Plug the headset into the jack located on the side of the handset (under the small rubber flap). Do not force the connection, but make sure the plug fits securely.



### Operating range

This cordless telephone operates within the maximum power allowed by the Federal Communications Commission (FCC). This handset and base can only communicate over a certain distance. The range may be affected by the weather or the construction of your home or office.

If you receive a call while you are out of range, the handset might not ring or if it does ring, the call might not connect when you press **ON**. Move closer to the base, then press **ON** to answer the call.

If you move out of range during a phone conversation, you might hear noise or interference, or you may lose the call. To improve reception, move closer to the base.

If you move out of range while on a call and the call is lost, your line may remain busy. To hang up properly, walk back into range, periodically pressing **OFF**.



## note

- If you repeatedly get a low battery indicator, even after charging overnight, the battery should be replaced.
- To reduce the risk of fire or injury to persons or damage to the telephone, charge the battery provided with this phone (or equivalent) in accordance with the instructions and limitations specified in this user's manual (see page 5).

## Batteries

### Battery care and maintenance

After your battery is fully charged, you can expect the following performance:

| Operation                   | Operating time |
|-----------------------------|----------------|
| While in use (talking)      | up to 8 hours  |
| While not in use (standby*) | up to 4 days   |

\* Handset is off the base unit or charger but not in use.

- The battery needs charging when:
  - A new battery is installed in the handset.
  - The phone beeps twice every five seconds.
  - The screen displays **LOW BATTERY** and the low battery icon.
- Place the handset in the base so the **CHARGE** light turns on. The battery is typically fully charged in 16 hours.
- You can keep the battery fully charged by returning the handset to the base after each use.

### Replacing the handset battery

1. Remove the battery compartment cover on the handset by pressing on the indentation and sliding the cover downward.
2. Lift out the old battery and disconnect.
3. Align the two holes in the new battery's plug with the socket pins, and snap the plug into place. Snap the battery in the compartment, as described in **Installation**, on page 4.
4. Replace the cover by sliding it up into place.
5. The new battery must be charged before using the phone. Place the handset in the base and allow it to charge for at least 16 hours the first charge. The telephone might operate before that, but for best performance, let the battery charge fully.

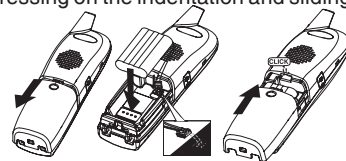

## Troubleshooting

If you have difficulty operating your phone, the suggestions below should solve the problem. If you still have difficulty after trying these suggestions, call the Supplier.

| Problem                       | Suggestion   |
|-------------------------------|--|
| My phone doesn't work at all. | <ul style="list-style-type: none"><li>• Make sure the power cord is plugged in.</li><li>• Make sure the telephone line cord is plugged firmly into the base unit and the telephone wall jack.</li><li>• Charge the battery in the handset for 16 hours. For optimum daily performance, return the handset to its base when not in use.</li><li>• Reset the base. Unplug the unit's electrical power. Wait for 15 seconds then plug it back in. Allow up to one minute for the handset and base to reset.</li><li>• You may need to purchase a new battery, please refer to the <b>Batteries</b> section (see page 32) of this user's manual.</li></ul> |
| I cannot get a dial tone.     | <ul style="list-style-type: none"><li>• First try all the suggestions above.</li><li>• Move the handset closer to the base. You might have moved out of range.</li><li>• Your line cord might be malfunctioning. Try installing a new line cord.</li><li>• If the previous suggestions don't work, disconnect the base unit from the telephone jack and connect a different phone. If there is no dial tone on that phone either, the problem is in your wiring or local service. Contact your local telephone company.</li></ul>  |

## Troubleshooting

| Problem  | Suggestion  |
|--|---|
| I cannot dial out.                                       | <ul style="list-style-type: none"><li>• Make sure you have a dial tone before dialing. The handset may take a second or two to find the base and produce a dial tone. This is normal. Wait an extra second before dialing.</li><li>• Make sure your phone is set to the correct dial mode for the type of service that you have (pulse or touchtone). Refer to the Installation section of this user's manual to set the dial mode.</li><li>• If the other phones in your home are having the issue, the problem is in your wiring or local service. Contact your local telephone company (charges may apply).</li><li>• Eliminate any background noise. Noise from a television, radio or other appliance may cause the phone to not dial out properly. If you cannot eliminate the background noise, first try muting the handset before dialing, or dialing from another room in your home with less background noise.</li></ul> |
| <b>UNABLE TO CALL, TRY AGAIN</b> displays on my handset. | <ul style="list-style-type: none"><li>• Move the handset closer to the base. You might have moved out of range.</li><li>• If the handset is in its base and the charging light does not come on, refer to <b>The charge light is off</b> (see page 37) in this troubleshooting guide.</li><li>• Reset the base. Unplug the unit's electrical power. Wait for 15 seconds then plug it back in. Allow up to one minute for the handset and base to reset.</li><li>• Other electronic products can cause interference with your cordless phone. Try installing your phone as far away from these types of electronic devices as possible: wireless routers, radios, radio towers, pager towers, cell phones, intercoms, room monitors, televisions, personal computers, kitchen appliances and other cordless phones.</li></ul>  |
| The batteries will not hold a charge.                    | <ul style="list-style-type: none"><li>• Charge the battery in the handset for 16 hours. For optimum daily performance, return the handset to its base when not in use.</li><li>• You may need to purchase a new battery, please refer to the <b>Batteries</b> (see page 32) section of this user's manual.</li><li>• Your phone might be malfunctioning. Please refer to the <b>Warranty</b> section of this user's manual for further instruction.</li></ul>   |

## Troubleshooting

| Problem  | Suggestion  |
|--|---|
| I get noise, static, or weak signal even when I'm near the base. | <ul style="list-style-type: none"><li>• Other electronic products can cause interference with your cordless phone. Try installing your phone as far away from these types of electronic devices as possible: wireless routers, radios, radio towers, pager towers, cell phones, intercoms, room monitors, televisions, personal computers, kitchen appliances and other cordless phones.</li><li>• Microwaves operate on the same frequency as your phone. It is normal to experience static on your phone while the microwave is running. Do not install this phone in the same outlet or near the microwave.</li><li>• If your phone is plugged in with a modem or surge protector, plug the phone (or modem/surge protector) into a different location. If this solves the problem, re-locate your phone or modem farther apart from one another, or use a different surge protector.</li><li>• Relocate your phone to a higher location. The phone will likely get better reception not installed in a low area.</li><li>• If the other phones in your home are having the issue, the problem is in your wiring or local service. Contact your local telephone company (charges may apply).</li></ul> |
| I hear other calls while using my phone.                         | <ul style="list-style-type: none"><li>• Disconnect your base unit from the telephone jack, and plug in a regular telephone. If you still hear other calls, the problem is probably in your wiring or local service. Call your local telephone company.</li></ul>  |

# Troubleshooting

| Problem   | Suggestion  |
|---|---|
| My handset does not ring when I receive a call. | <ul style="list-style-type: none"><li>• Make sure you have the ringer activated. Refer to the section(s) on ringer selection in this user's manual.</li><li>• Make sure the telephone line cord is plugged firmly into the base unit and the telephone jack. Make sure the power cord is plugged in.</li><li>• You may be too far from the base unit.</li><li>• Charge the battery in the handset for 16 hours. For optimum daily performance, return the handset to its base when not in use.</li><li>• You may have too many extension phones on your telephone line to allow all of them to ring. Try unplugging some of the other phones.</li><li>• The layout of your home or office might be limiting the operating range. Try moving the base to another location, preferably on an upper floor.</li><li>• If the other phones in your home are having the issue, the problem is in your wiring or local service. Contact your local telephone company (charges may apply).</li><li>• Test a working phone at the phone jack. If another phone has the same problem, the problem is the phone jack. Contact your local telephone company (charges may apply).</li><li>• Other electronic products can cause interference with your cordless phone. Try installing your phone as far away from these types of electronic devices as possible: wireless routers, radios, radio towers, pager towers, cell phones, intercoms, room monitors, televisions, personal computers, kitchen appliances and other cordless phones.</li><li>• Your line cord might be malfunctioning. Try installing a new line cord.</li></ul> |

## Troubleshooting

| Problem   | Suggestion   |
|---|--|
| My calls fade or cut in and out while I'm using my handset. | <ul style="list-style-type: none"><li>• Other electronic products can cause interference with your cordless phone. Try installing your phone as far away from these types of electronic devices as possible: wireless routers, radios, radio towers, pager towers, cell phones, intercoms, room monitors, televisions, personal computers, kitchen appliances and other cordless phones.</li><li>• Microwaves operate on the same frequency as your phone. It is normal to experience static on your phone while the microwave is running. Do not install this phone in the same outlet or near the microwave.</li><li>• If your phone is plugged in with a modem or surge protector, plug the phone (or modem/surge protector) into a different location. If this solves the problem, re-locate your phone or modem farther apart from one another, or use a different surge protector.</li><li>• Relocate your phone to a higher location. The phone will get better reception not installed in a low area.</li><li>• If the other phones in your home are having the issue, the problem is in your wiring or local service. Contact your local telephone company (charges may apply).</li></ul> |
| The charge light is off.                                    | <ul style="list-style-type: none"><li>• Clean the handset and base charging contact each month using a pencil eraser or cloth.</li><li>• Make sure the power and line cords are plugged in correctly and firmly.</li><li>• Reset the base. Unplug the unit's electrical power. Wait for 15 seconds then plug it back in. Allow up to one minute for the handset and base to reset.</li><li>• Your phone might be malfunctioning. Please refer to the <b>Limited Warranty</b> section of this user's manual for further instruction.</li></ul>  |

## Troubleshooting

| Problem                               | Suggestion  |
|---------------------------------------|---|
| My Caller ID isn't working.           | <ul style="list-style-type: none"><li>• Caller ID is a subscription service You must subscribe to this service for this feature to work on your phone.</li><li>• Your caller must be calling from an area that supports caller ID.</li><li>• Both you and your caller's telephone companies must use caller ID compatible equipment.</li></ul>  |
| Common cure for electronic equipment. | <p>If the unit does not seem to be responding normally, then try putting the handset in its base. If it does not seem to respond, do the following (in the order listed):</p> <ol style="list-style-type: none"><li>1. Disconnect the power to the base.</li><li>2. Disconnect the handset battery, and spare battery, if applicable.</li><li>3. Wait a few minutes.</li><li>4. Connect power to the base.</li><li>5. Re-install the battery(ies).</li><li>6. Wait for the handset to re-establish its link with the base. To be safe, allow up to one minute for this to take place.</li></ol> |

# Maintenance

Taking care of your telephone

Your cordless telephone contains sophisticated electronic parts, so it must be treated with care.

## **Avoid rough treatment**

Place the handset down gently. Save the original packing materials to protect your telephone if you ever need to ship it.

## **Avoid water**

Your telephone can be damaged if it gets wet. Do not use the handset outdoors in the rain, or handle it with wet hands. Do not install your base unit near a sink, bathtub or shower.

## **Electrical storms**

Electrical storms can sometimes cause power surges harmful to electronic equipment. For your own safety, use caution when using electric appliances during storms.

## **Cleaning your telephone**

Your telephone has a durable plastic casing that should retain its luster for many years. Clean it only with a soft cloth slightly dampened with water or a mild soap. Do not use excess water or cleaning solvents of any kind.

# Warranty

The Supplier warrants, to the original purchaser only, the material and workmanship of this product for ONE YEAR from the date of purchase. We will repair or replace, at our option, this product without charge should it fail due to a defect in material or workmanship within that time period.

This warranty does not apply to loss or damage that is the result of accident, misuse or negligence. All other warranties, expressed, implied or statutory, including warranties of fitness for a particular purpose, are limited to the time period listed and are otherwise excluded from this warranty if unauthorized repairs are attempted. Additionally, the Supplier shall not be liable for any incidental or consequential damage or commercial loss, nor for any other loss or damages.

The Supplier assumes no responsibility for products sent without prior return authorization.



# Important safety instructions

When using your telephone equipment, basic safety precautions should always be followed to reduce the risk of fire, electric shock and injury, including the following:

1. Read and understand all instructions.
2. Follow all warnings and instructions marked on the product.
3. Unplug this product from the wall outlet before cleaning. Do not use liquid or aerosol cleaners. Use a damp cloth for cleaning.
4. Do not use this product near water (for example, near a bath tub, kitchen sink or swimming pool).
5. Do not place this product on an unstable surface, such as a table, shelf or stand. The product may fall, causing serious damage.
6. Slots and openings in the back or bottom of the base unit and handset are provided for ventilation. To protect them from overheating, these openings must not be blocked by placing the product on a soft surface such as a bed, sofa or rug. This product should never be placed near or over a radiator or heat register. This product should not be placed in any area where proper ventilation is not provided.
7. This product should be operated only from the type of power source indicated on the marking label. If you are not sure of the type of power supply in your home, consult your dealer or local power company.
8. Do not allow anything to rest on the power cord. Do not install this product where the cord may have anyone walking on it.
9. Never push objects of any kind into this product through slots in the base or handset as they may touch dangerous voltage points or short out parts that could result in a risk of fire or electric shock. Never spill liquid of any kind on the product.
10. To reduce the risk of electric shock, do not disassemble this product, but take it to an authorized service facility. Opening or removing parts of the base or handset other than specified access doors may expose you to dangerous voltages or other risks. Incorrect reassembling can cause electric shock when the product is subsequently used.
11. Do not overload wall outlets and extension cords as this can result in the risk of fire or electric shock.
12. Unplug this product from the wall outlet and refer servicing to an authorized service facility under the following conditions:
  - A. When the power supply cord or plug is damaged or frayed.
  - B. If liquid has been spilled onto the product.
  - C. If the product has been exposed to rain or water.
  - D. If the product does not operate normally by following the operating instructions. Adjust only those controls that are covered by the operating instructions, as improper adjustment of other controls may result in damage and often requires extensive work by an authorized technician to restore the product to normal operation.
  - E. If the product has been dropped and the base and/or handset has been damaged.
  - F. If the product exhibits a distinct change in performance.
13. Avoid using a telephone (other than cordless) during an electrical storm. There is a remote risk of electric shock from lightning.
14. Do not use the telephone to report a gas leak in the vicinity of the leak.
15. Only put the handset of your telephone next to your ear when it is in normal talk.

**SAVE THESE INSTRUCTIONS**

# FCC, ACTA and IC regulations

## FCC Part 15

This equipment has been tested and found to comply with the requirements for a Class B digital device under Part 15 of the Federal Communications Commission (FCC) rules. These requirements are intended to provide reasonable protection against harmful interference in a residential installation. This equipment generates, uses and can radiate radio frequency energy and, if not installed and used in accordance with the instructions, may cause harmful interference to radio communications. However, there is no guarantee that interference will not occur in a particular installation. If this equipment does cause harmful interference to radio or television reception, which can be determined by turning the equipment off and on, the user is encouraged to try to correct the interference by one or more of the following measures:

- \* Reorient or relocate the receiving antenna.
- \* Increase the separation between the equipment and receiver.
- \* Connect the equipment into an outlet on a circuit different from that to which the receiver is connected.
- \* Consult the dealer or an experienced radio/TV technician for help.

Changes or modifications to this equipment not expressly approved by the party responsible for compliance could void the user's authority to operate the equipment.

To ensure safety of users, the FCC has established criteria for the amount of radio frequency energy that can be safely absorbed by a user or bystander according to the intended usage of the product. This product has been tested and found to comply with the FCC criteria. The handset may be safely held against the ear of the user. The base unit shall be installed and used such that parts of the user's body other than the hands are maintained at a distance of approximately 20 cm (8 inches) or more. If you choose to use a clipping device, please make sure to only use the supplied belt clip.

## FCC Part 68 and ACTA

This equipment complies with Part 68 of the FCC rules and with technical requirements adopted by the Administrative Council for Terminal Attachments (ACTA). The label on the back or bottom of this equipment contains, among other things, a product identifier in the format US:AAAEQ##TXXXX. This identifier must be provided to your local telephone company upon request.

The plug and jack used to connect this equipment to premises wiring and the telephone network must comply with applicable Part 68 rules and technical requirements adopted by ACTA. A compliant telephone cord and modular plug is provided with this product. It is designed to be connected to a compatible modular jack that is also compliant. An RJ11 jack should normally be used for connecting to a single line and an RJ14 jack for two lines. See Installation Instructions in the user's manual.

The Ringer Equivalence Number (REN) is used to determine how many devices you may connect to your telephone line and still have them ring when you are called. The REN for this product is encoded as the 6th and 7th characters following the US: in the product identifier (e.g., if ## is 03, the REN is 0.3). In most, but not all areas, the sum of all RENs should be five (5.0) or less. For more information, please contact your local telephone company.

This equipment may not be used with Party Lines. If you have specially wired alarm dialing equipment connected to your telephone line, ensure the connection of this equipment does not disable your alarm equipment. If you have questions about what will disable alarm equipment, consult your telephone company or a qualified installer.

If this equipment is malfunctioning, it must be unplugged from the modular jack until the problem has been corrected. Repairs to this telephone equipment can only be made by the manufacturer or its authorized agents. For repair procedures, follow the instructions outlined under the Limited Warranty.

If this equipment is causing harm to the telephone network, the telephone company may temporarily discontinue your telephone service. The telephone company is required to notify you before interrupting service. If advance notice is not practical, you will be notified as soon as possible. You will be given the opportunity to correct the problem and the telephone company is required to inform you of your right to file a complaint with the FCC. Your telephone company may make changes in its facilities, equipment, operation, or procedures that could affect the proper functioning of this product. The telephone company is required to notify you if such changes are planned.

If this product is equipped with a corded or cordless handset, it is hearing aid compatible.

If this product has memory dialing locations, you may choose to store emergency telephone numbers (e.g., police, fire, medical) in these locations. If you do store or test emergency numbers, please:

## FCC, ACTA and IC regulations

- \* Remain on the line and briefly explain the reason for the call before hanging up.
- \* Perform such activities in off-peak hours, such as early morning or late evening.

### Industry Canada

This equipment complies with regulations RSS210 and CS-03 of Industry Canada. Operation is subject to the following two conditions: (1) this device may not cause interference, and (2) this device must accept any interference, including interference that may cause undesired operation of the device.

The term "IC: " before the certification/registration number only signifies that the Industry Canada technical specifications were met.

The Ringer Equivalence Number (REN) for this terminal equipment is 0.1. The REN is an indication of the maximum number of devices allowed to be connected to a telephone interface. The termination on an interface may consist of any combination of devices subject only to the requirement that the sum of the RENs of all the devices does not exceed five.

## The RBRC® seal



The RBRC® Seal on the nickel-metal-hydride battery indicates that VTech Communications, Inc. is voluntarily participating in an industry program to collect and recycle these batteries at the end of their useful lives, when taken out of service within the United States and Canada.

The RBRC® program provides a convenient alternative to placing used nickel-metal-hydride batteries into the trash or municipal waste, which may be illegal in your area.

VTech's participation in RBRC® makes it easy for you to drop off the spent battery at local retailers participating in the RBRC® program or at authorized VTech product service centers. Please call 1-800-8-BATTERY™ for information on Ni-MH battery recycling and disposal bans/restrictions in your area. VTech's involvement in this program is part of its commitment to protecting our environment and conserving natural resources.

RBRC® is a registered trademark of Rechargeable Battery Recycling Corporation.

## Technical specifications

Enhanced 5.8GHz technology—your phone operates on a dual band transmission that combines the best of 5.8GHz and 2.4GHz technologies, providing enhanced performance over standard cordless telephones.

|                         |  |
|-------------------------|--|
| Frequency Control       | Crystal controlled<br>PLL synthesizer  |
| Transmit Frequency      | Base: 5725–5850 MHz<br>Handset: 2400–2483.5 MHz  |
| Receive Frequency       | Base: 2400–2483.5 MHz<br>Handset: 5725–5850 MHz  |
| Channels                | 95   |
| Nominal Effective Range | Maximum power allowed by FCC and IC. Actual operating range may vary according to environmental conditions at the time of use. |
| Size                    | Handset: 42mm X 52mm X 163mm<br>Base: 120mm X 118mm X 63mm   |
| Weight                  | Handset: 124 grams<br>Base: 196 grams  |
| Power Requirements      | Handset: 600mAH NiMH Battery<br>Base: 9V DC @ 400mA  |
| Memory                  | Phonebook: 50 Memory locations, 16 characters for name, 32 digits for number per location<br>Call Log: 50 Memory locations     |

# Index

## A

- About call history 24
- Access voicemail 26
- Additional information 33
- Answering calls 12

## B

- Base display 9
- Base unit layout 11
- Basic operation 9
- Batteries 32
- Battery care and maintenance 32
- Before you begin 3
- Belt clip 3, 6

## C

- Caller ID 23-25
- Call forward 15
- Change 3-way calling number 30
- Change auto call back number 29
- Change PPU key setting 29
- Change repeat dialing number 30
- Charge the handset battery 6
- Check for dial tone 6
- Choose a location 4
- Clear voicemail 26
- Conference call 13
- Custom pay-per-use (PPU) features 29-30

## D

- Delete a phonebook entry 22

## 44

- Delete a specific call 24
- Delete all calls 24
- Delete records from call history 24
- Dial a displayed number 24
- Dial type 19

## E

- Edit a phonebook entry 22

## F

- FCC, ACTA and IC regulations 41-42
- Find handset 15
- Flash function 12

## G

- Getting started 3

## H

- Handset and base indicators 9
- Handset display 9
- Handset display screen messages 16-17
- Handset layout 10
- Handset operation 12-17
- Headset 31
- Headset operation 31

## I

- Important safety instructions 40
- Installation 4-7

# Index

Install handset battery 4

Intercom call 14

## K

Key tone 19

## L

Language 19

## M

Maintenance 39

Making calls 12

Mute 10, 13

## O

Operating range 31

## P

Parts checklist 3

Phonebook 20-22

PPU keys on handset 29

Program the erase key 28

Program the password 27

Program the play key 27

Program the skip key 28

Program the voicemail key 27

## R

Re-register existing handsets to a new base 7

Redial 12

Replacing the handset battery 32

Reset all codes 28

Review/dial from the phonebook 21

Review call history 24

Ringer volume 18

Ring tone 18

## S

Shared call log 23

Store a call history record in the directory 25

Store a new entry 20

## T

Table/desk installation 5

Technical specifications 43

Telephone settings 18-19

The RBRC® seal 42

To register your accessory handsets 7

Transferring calls 13

Troubleshooting 33-38

## V

Voicemail 26-28

Volume control 13

## W

Wall mounting 8

Warranty 39

Printed in China.

91-000XXX-010-000

BellSouth  
**Premium Systems®**